

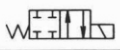
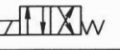
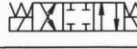

ORDERING CODES

<p>Selenoid Valf Solenoid Valve</p> <p>Nominal Ölçü RH06-RH10 Nominal Bore(mm)</p> <p>Hidrolik Şema Tablo 1 Hydraulic Schema Table 1</p> <p>Kontrol Şekilleri / Type of Control</p> <p>Selenoid / Solenoid1 Hidrolik / Hydraulic2 Mekanik / Mechanic4 Pnomatik / Pneumatic6 Manual / Manual7</p>	<table border="1" style="margin: auto;"> <tr> <td style="width: 20px; height: 20px; text-align: center;">RH</td> <td style="width: 20px; height: 20px;"></td> <td style="width: 20px; height: 20px;"></td> <td style="width: 20px; height: 20px;"></td> </tr> </table>	RH				<p>Modifikasyon Modification</p> <p>Voltaj/ Frekans/ Voltage Frequency</p> <p>[V] [Hz]</p> <p>12 00 24 00 110 50 220/380 50</p>
RH						

HİDROLİK ŞEMA (Tablo 1)
HYDRAULIC SCHEMA (Table 1)

SİPARİŞ KODU / ORDERING CODE	SEMBOL / SYMBOL	SİPARİŞ KODU / ORDERING CODE	SEMBOL / SYMBOL	SİPARİŞ KODU / ORDERING CODE	SEMBOL / SYMBOL
00		16		39	
01		17		40	
02		18		41	
04		20*		42	
05		21		45	
06		24		61	
08		26		62	
10		27		64	
11		28		68	
12		32		70	
13		33		83	
14		36		20*-with detent	

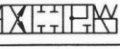
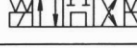
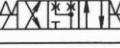
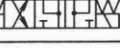
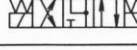
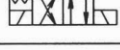
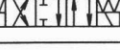
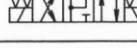
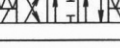
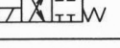
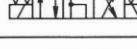
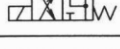
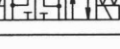
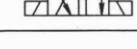
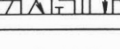
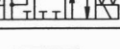
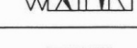
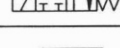
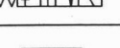
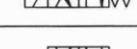
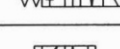
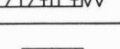
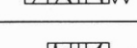
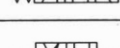
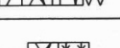
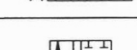
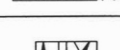
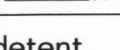
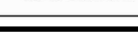
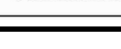
Montaj Arayüzü: ISO 4401-AV-03-4-A
Mounting Interface: ISO 4401-AV-03-4-A

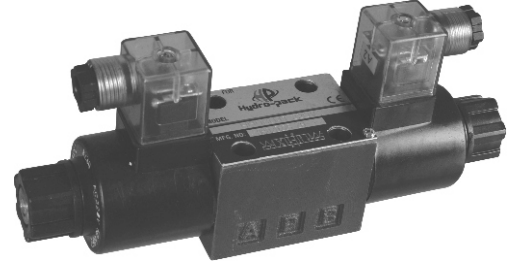
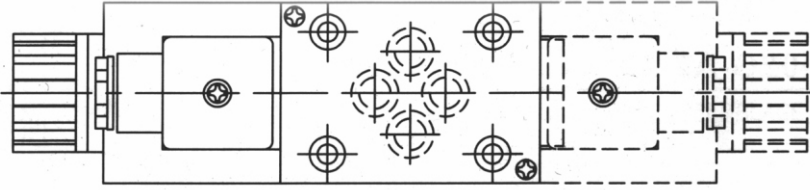

RH06.../220V AC

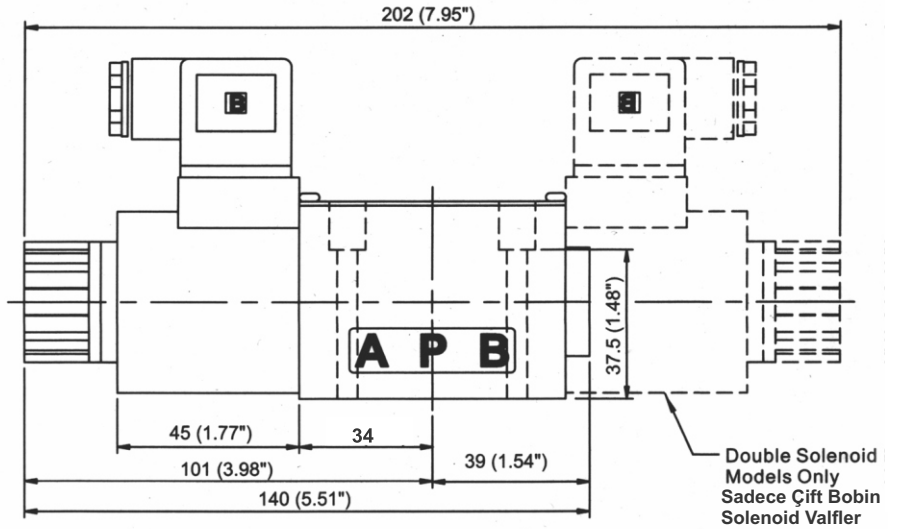
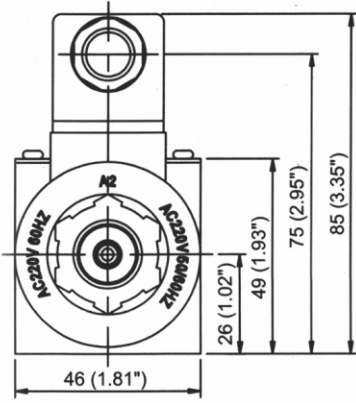

RH06.../12V;24V DC

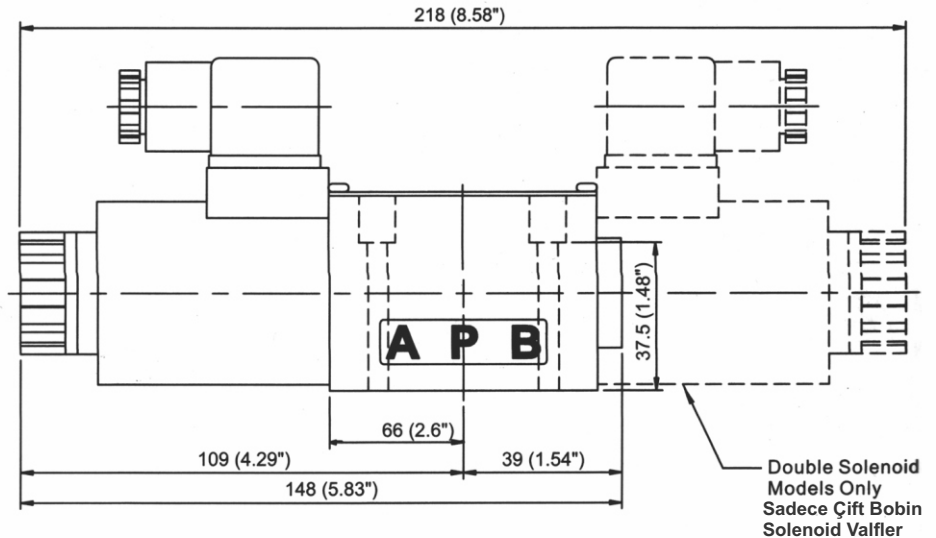
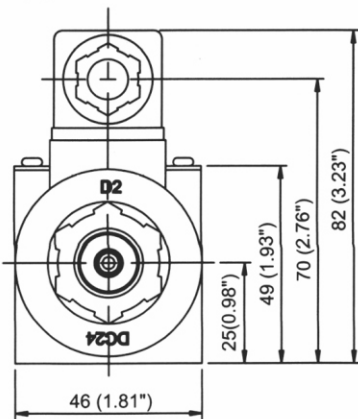
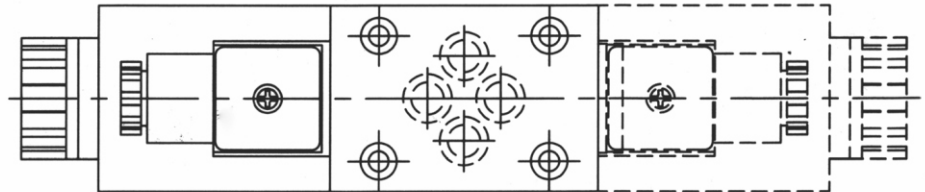

Montaj Arayüzü: ISO 4401-AC-05--4-A
Mounting Interface: ISO 4401-AC-05--4-A
Unit: mm

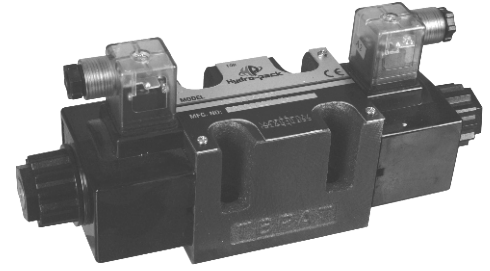
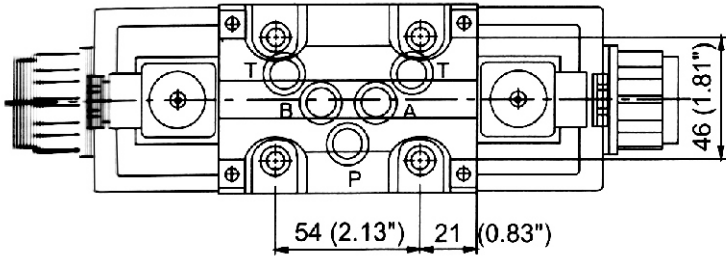

RH10.../220V AC

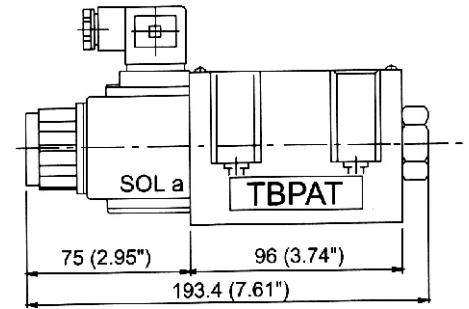
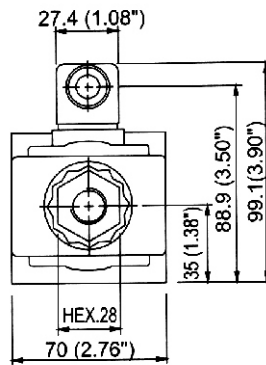
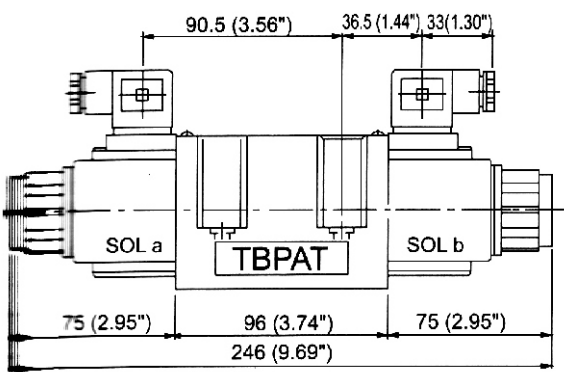

Montaj Arayüzü: ISO 4401-AC-05--4-A
Mounting Interface: ISO 4401-AC-05--4-A
Unit: mm

RH10.../12V;24V DC

